

1 What You Need

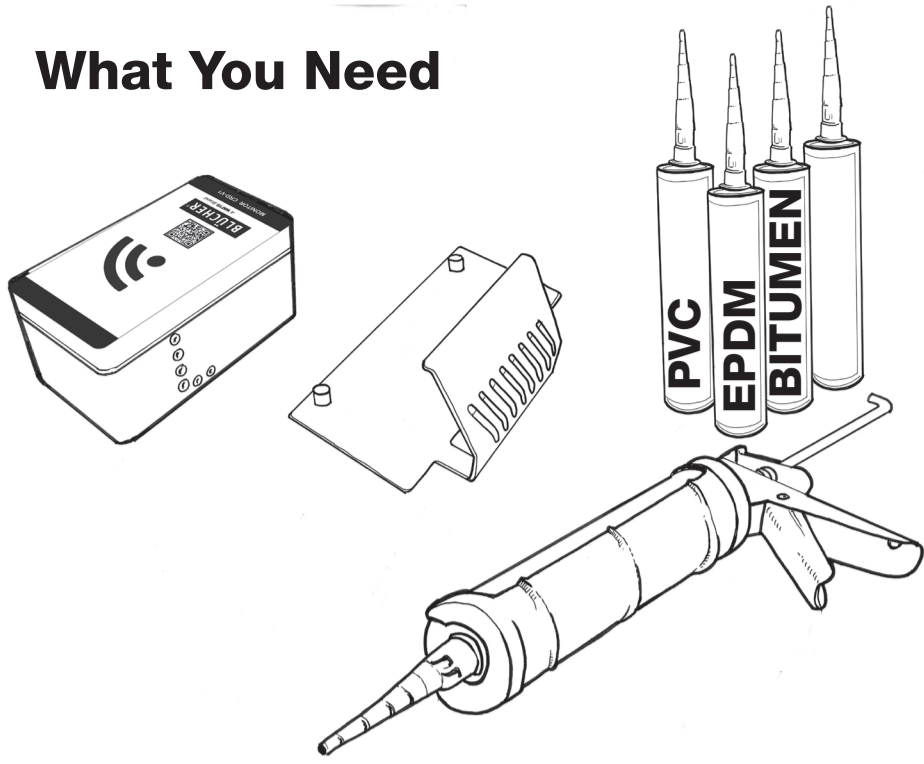

2 Where to Mount

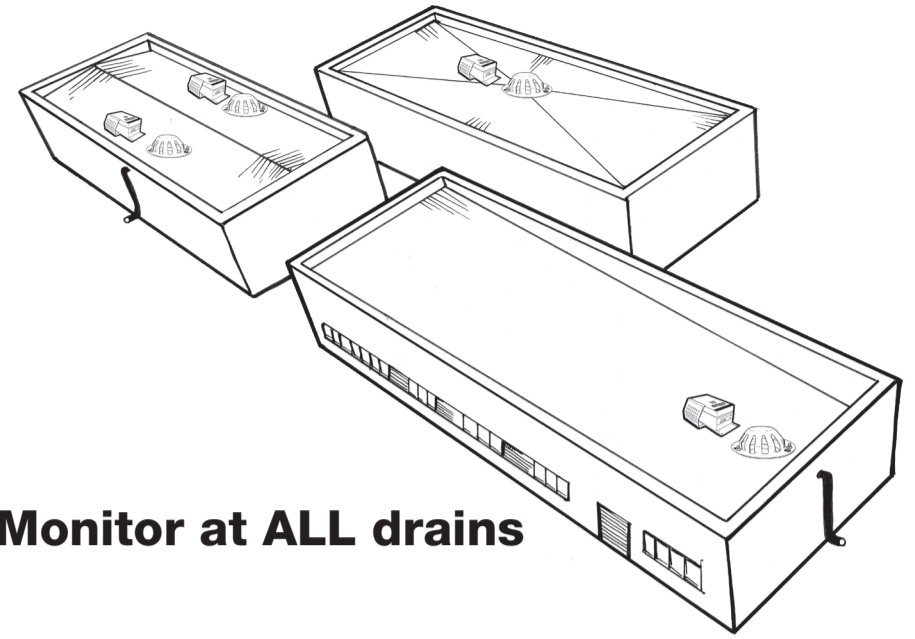

3 Mount in Drain Level

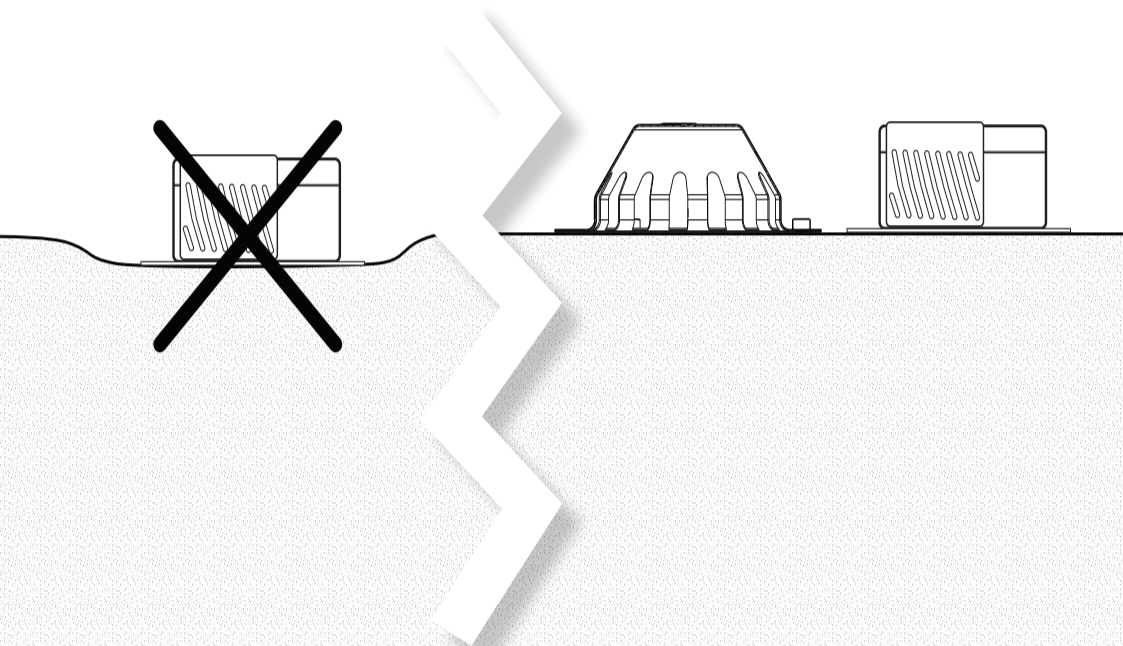

4 If Needed Install Monitor on Bracket

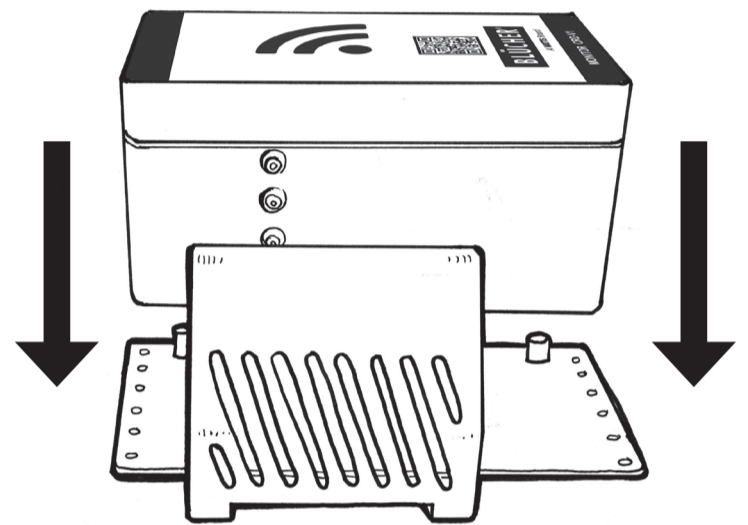

5 Monitor Install



6 Position the Monitor

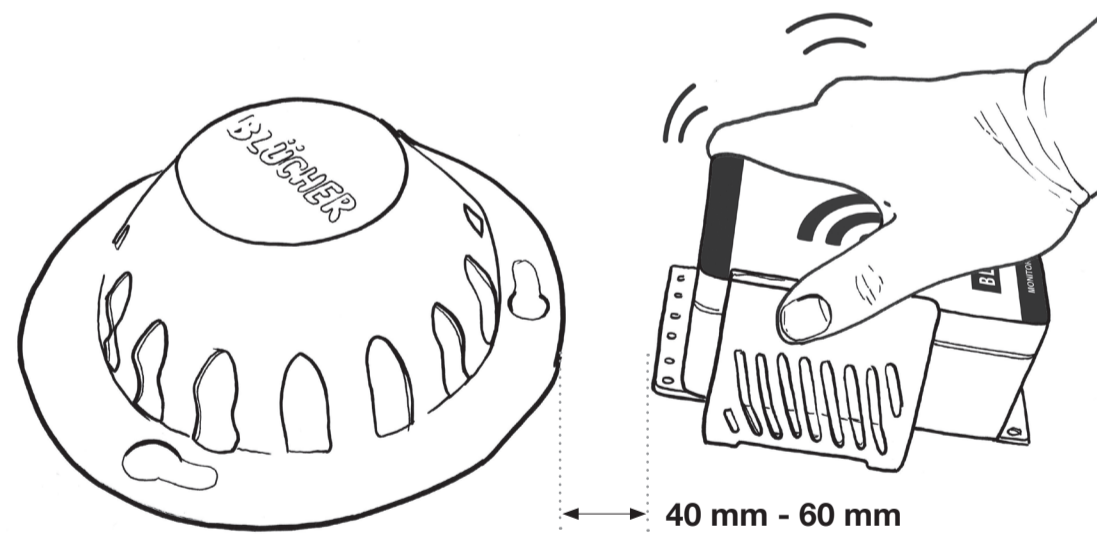

Service and Maintenance

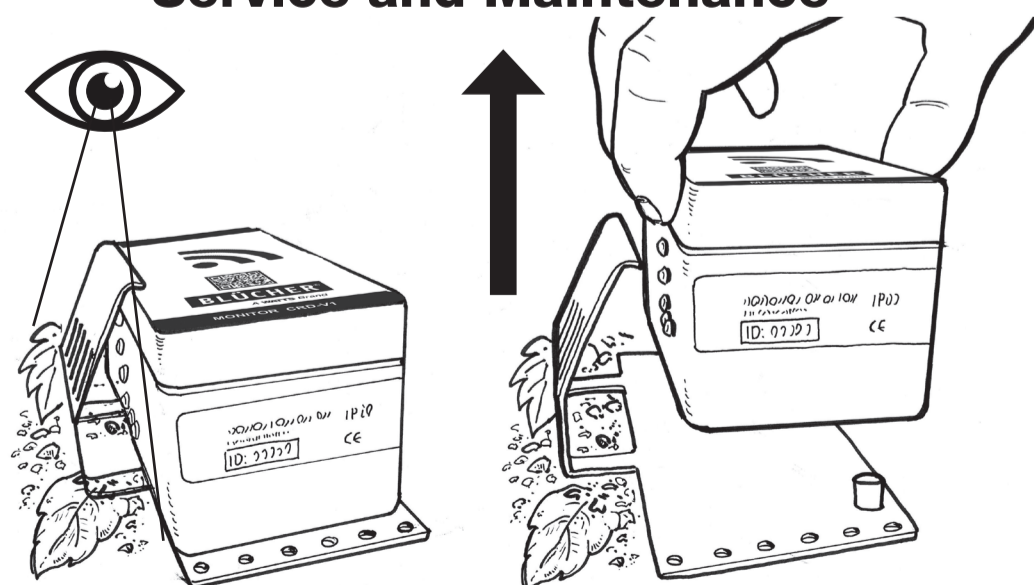

Remove and clean away dirt

BLÜCHER Connected Roof MONITOR



BLÜCHER®
A WATTS Brand

More info

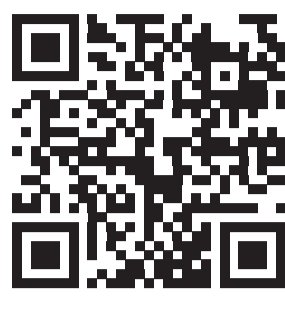

www.blucher.com/connected-roof

BLÜCHER®
A WATTS Brand